



- Cadmium - free contacts
- Height 16 mm
- 5000 V / 10 mm reinforced insulation
- **For surface mounting SMT**
- Coil AC and DC
- Recyclable packing

Contacts

Contact number & arrangement		1C/O
Contact material		AgNi , AgNi/Au 5 µm, AgSnO ₂
Max. switching voltage	AC/DC	400 V / 300 V
Min. switching voltage		5 V AgNi, 5 V AgNi/Au 5 µm, 10 V AgSnO ₂
Rated load	AC1	16 A / 250 V AC
	DC1	16 A / 24 V DC
Min. switching current		5 mA AgNi, 2 mA AgNi/Au 5 µm, 10 mA AgSnO ₂
Max. inrush current		30 A AgSnO ₂
Rated current		16 A
Max. breaking capacity	AC1	4 000 VA
Min. breaking capacity		0,3 W AgNi, 0,05 W AgNi/Au 5 µm, 1 W AgSnO ₂
Resistance		≤ 100 mΩ
Max. operating frequency		
• at rated load	AC1	600 cycles/hour
• no load		72 000 cycles/hour

Coil

Rated voltage	50/60 Hz AC	12...240 V
	DC	3...110 V
Must release voltage		AC: ≥ 0,15 U _n DC: ≥ 0,1 U _n
Operating range of supply voltage		see Table 1, 2 and Fig. 4, 5
Rated power consumption	AC	0,75 VA
	DC	0,4...0,48 W

Insulation

Insulation category		C250 / B400
Insulation rated voltage		400 V AC
Dielectric strength		
• coil - contact		5 000 V AC
• contact - contact		1 000 V AC
Contact - coil distance		
• clearance		≥ 10 mm
• creepage		≥ 10 mm

General data

Operating time (typical value)		7 ms
Release time (typical value)		3 ms
Electrical life		
• resistive AC1		> 0,7 x 10 ⁵ 16 A, 250 V AC
• cos φ		see Fig. 2
• L/R=40 ms		> 10 ⁵ 0,12 A, 220 V DC
Mechanical life (cycles)		> 3 x 10 ⁷
Dimensions (L x W x H)		29 x 12,7 x 15,7 mm
Weight		14 g
Ambient temperature		
• storing		-40...+85 °C
• operating		AC: -40...+70 °C DC: -40...+85 °C
Cover protection category		IP 40
Shock resistance		30 g
Vibration resistance		10 g 10...150 Hz
Solder bath temperature		max. 270 °C
Soldering time		max. 5 s

Standard contact material marked with bolt type.



Coil data - DC voltage version

Table 1

Coil code	Rated voltage V DC	Coil resistance ±10% at 20 °C Ω	Coil operating range at 20 °C V DC	
			min.	max.
1003	3	22	2,1	7,6
1005	5	60	3,5	12,7
1006	6	90	4,2	15,3
1009	9	200	6,3	22,9
1012	12	360	8,4	30,6
1018	18	710	12,6	45,9
1024	24	1 440	16,8	61,2
1036	36	3 140	25,2	91,8
1048	48	5 700	33,6	122,4
1060	60	7 500	42,0	153,0
1110	110	25 200	77,0	280,0

Coil data - AC 50/60 Hz voltage version

Table 2

Coil code	Rated voltage V AC	Coil resistance at 20 °C Ω	Tolerance of resistance	Coil operating range at 20 °C V AC	
				min.	max.
5012	12	100	±10%	9,6	13,2
5024	24	400	±10%	19,2	28,8
5048	48	1 550	±10%	38,4	57,6
5060	60	2 600	±10%	48,0	72,0
5110	110	8 900	±10%	88,0	132,0
5115	115	9 600	±10%	92,0	138,0
5120	120	10 200	±10%	96,0	144,0
5220	220	35 500	±10%	176,0	264,0
5230	230	38 500	±10%	184,0	276,0
5240	240	42 500	±15%	192,0	288,0

Dimensions

Connections diagrams
(pin side view)

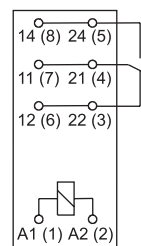
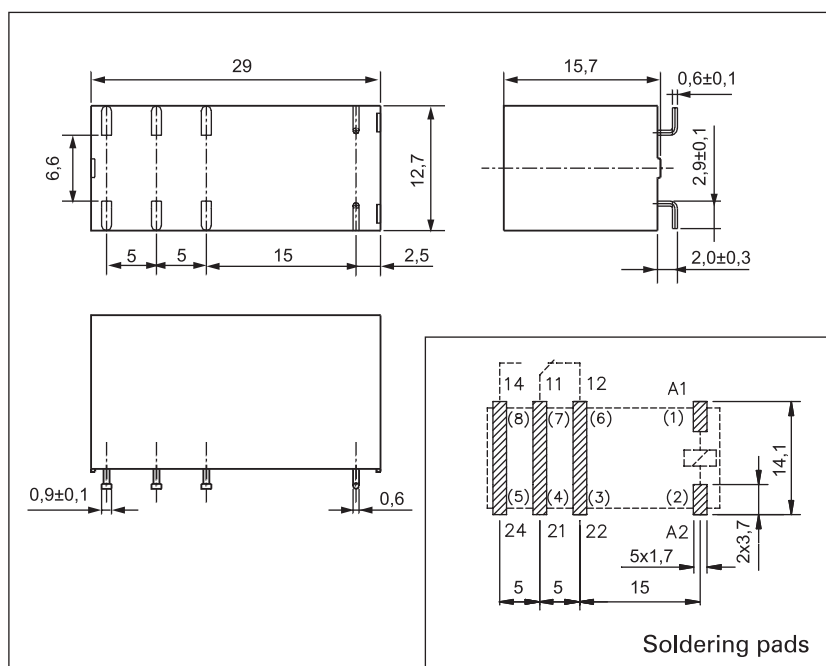

Terminal (pin)	A1(1); A2(2)	22(3); 21(4); 24(5); 12(6); 11(7); 14(8)
[mm]	∅ 0,6	0,5 x 0,9

RM85 SMT terminals are doubled for each contact. Both terminals are to be used while connecting to load.



Electrical life at AC resistive load

Fig. 1

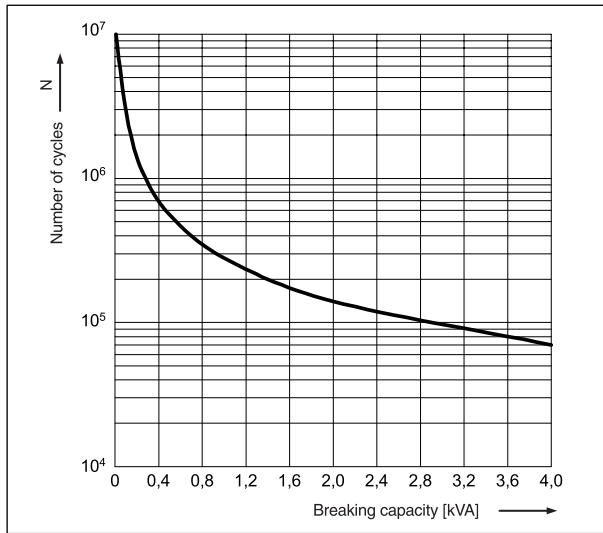

Electrical life reduction factor at AC inductive load

Fig. 2

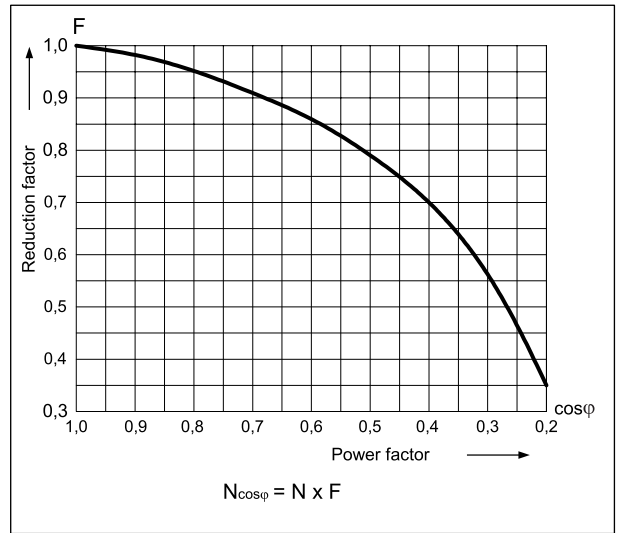

Max. DC resistive load breaking capacity

Fig. 3

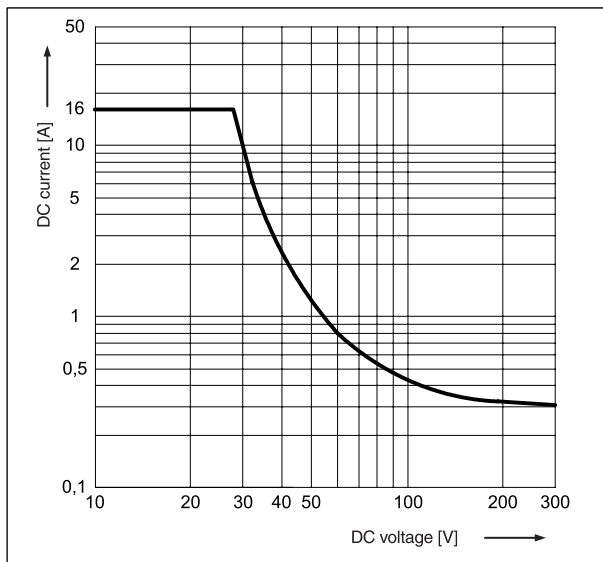

Coil operating range - DC

Fig. 4

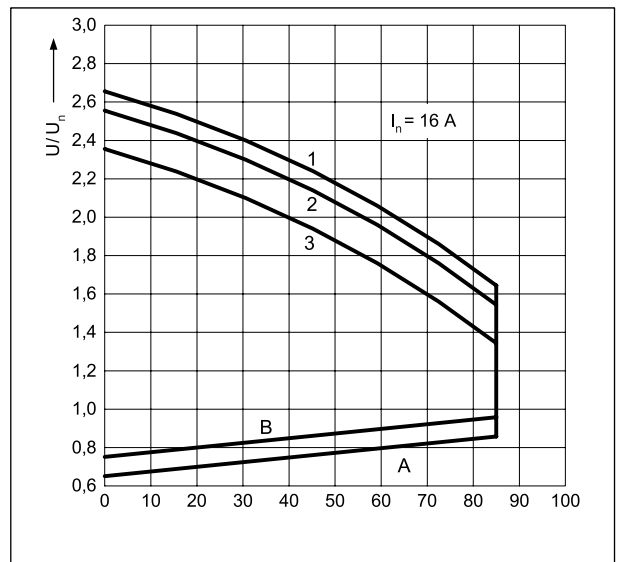

For soldering data please contact manufacturer.

Coil operating range - DC

Fig. 5

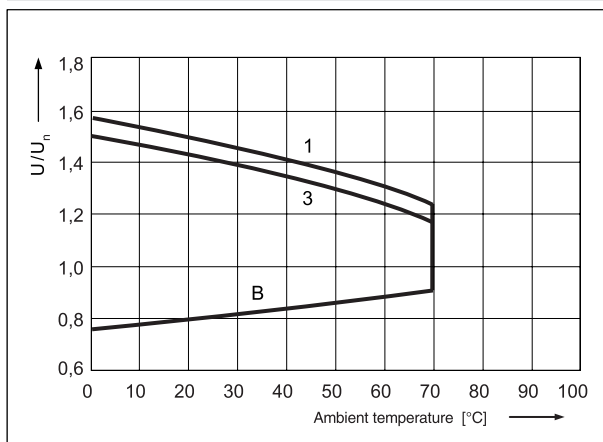

Description of Fig. 4 and 5

A - relations between make voltage and ambient temperature at no load on contacts. Coil temperature and ambient temperature are equal before coil energizing. Make voltage is not higher than the value read on Y axis (multiplication of rated voltage).

B - relations between make voltage and ambient temperature after initial coil heating up with $1,1 U_n$, at continues load of I_n on contacts. Make voltage is not higher than the value read on Y axis (multiplication of rated voltage).

1, 2, 3 - values on Y axis represent allowed overvoltage on coil at certain ambient temperature and contact load:

- 1 - no load
- 2 - 50% of rated load
- 3 - rated load



Mounting

Relays **RM85 SMT** are designed for surface mounting SMT.

Ordering codes

