

Part Number	Description
LS24D16C	16A, 240 Vac
LS24D21C	21A, 240 Vac
LS60D22C	22A, 600 Vac
LS24D27C	27A, 240 Vac
LS60D27C	27A, 600 Vac
LS60D30C	30A, 600 Vac

**Part Number Explanation**

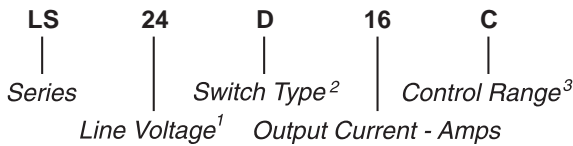

**NOTES**

- 1) Line Voltage (nominal): 24 = 240 Vac; 60 = 600 Vac
- 2) Switch Type: D = Zero-cross turn-on
- 3) Control Range: C = 4-14 Vdc (N = 8-32 Vdc also available)

**MECHANICAL SPECIFICATION**

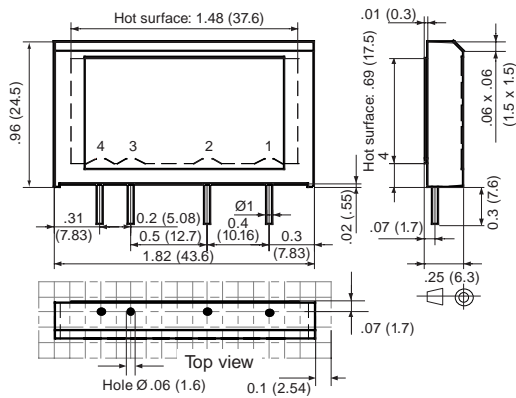

WEIGHT: 0.53 oz. (15g)      TOLERANCES:  $\pm$ 0.01

Figure 1 — LS relays; dimensions in inches (mm)  
(See Figure 12 for LS with HS1)

**TYPICAL APPLICATION**

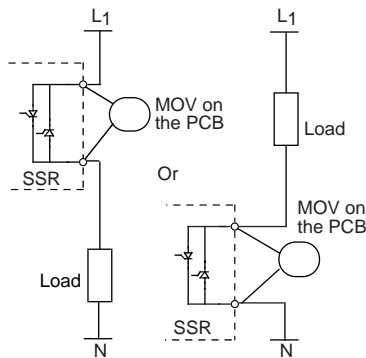

Figure 2 — LS relays



**FEATURES/BENEFITS**

- Industry standard package
- Designed for external heat-sink attachment
- Over-sized thyristor ratings
- Direct-copper bonding technology

**DESCRIPTION**

These solid-state single inline package (SIP) relays are designed for mounting on printed circuit boards. The Series LS relays facilitate heat sinking by providing an interface surface. The relays are designed with 16A, 25A and 50A thyristors. They can switch loads with high starting currents. The nominal switched currents depend on the size of the heat sink and are limited by the cross section of the tracks of the printed circuit (mainly 25A/30A). The relays use a direct-bonded copper substrate for thermal efficiency, thermal stress performance and long-life expectancy.

**APPLICATIONS**

- Motor control — Pumps, reversing, integration of relays in terminal boxes
- Lamp control — Infrared drying, traffic lights, theater lighting

**APPROVALS**

All models are UL recognized.  
UL File Number: E128555.

**BLOCK DIAGRAM**

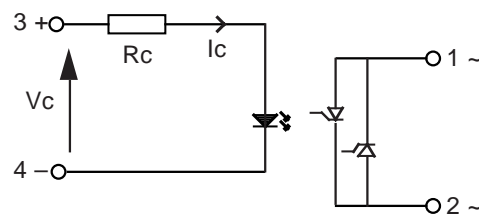

Figure 3 — LS relays

**INPUT (CONTROL) SPECIFICATION**

	Min	Max	Units
Control Range	4	14	Vdc
Input Current Range	6.5	30	mAdc
Must Turn-off Voltage		1	Vdc
Input Resistance (Typical)		440	Ohms

**OUTPUT (LOAD) SPECIFICATION**

	Min	Max	Unit
Operating Range			
LS24	12	280	Vrms
LS60	24	600	Vrms

**Peak Voltage**

LS24D16C		600	Vpeak
LS60D22C		1200	Vpeak

**Load Current Range**

LS24D16C	.005	16*	Arms
LS24D21C	.005	25*	Arms
LS60D22C	.005	25*	Arms
LS24D27C	.005	30*	Arms
LS60D27C	.005	30*	Arms
LS60D30C	.005	30*	Arms

\*Limited by the heat sink

**Maximum Surge Current Rating (Non-Repetitive)**

(See Figure 6)

LS24D16C		160	Apeak
LS24D21C		250	Apeak
LS60D22C		300	Apeak
LS24D27C		600	Apeak
LS60D27C		600	Apeak
LS60D30C		1000	Apeak

**On-State Voltage Drop**

All relays		1.6	V
------------	--	-----	---

**Zero-Cross Window (Typical)**

All relays		±12	V
------------	--	-----	---

**Off-State Leakage Current (60Hz)**

All relays		1	mA
------------	--	---	----

**CONTROL CHARACTERISTIC**

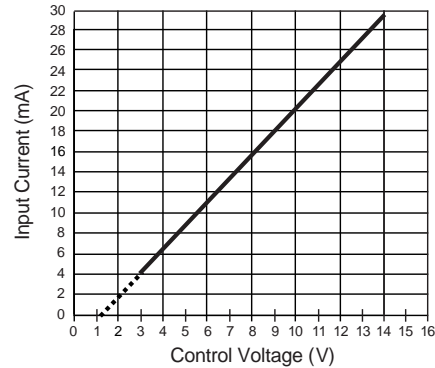

Figure 4 — LS relays

**THERMAL CHARACTERISTICS**

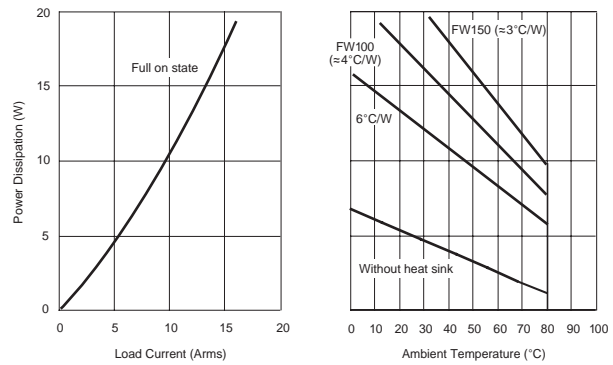

Figure 5a — LS24D16C relay

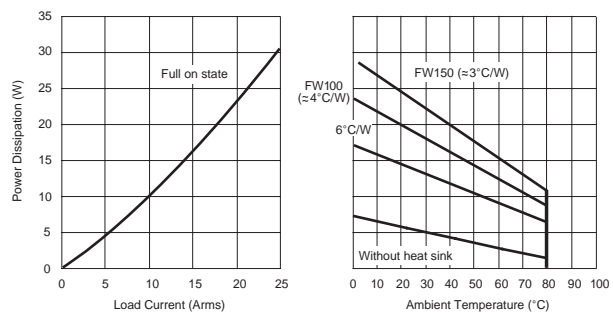

Figure 5b — LS24D21C, LS60D22C relays

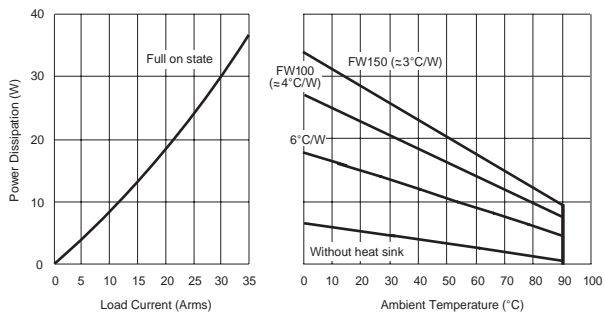

Figure 5c — LS24D27C, LS60D27C, LS60D30C relays

**OUTPUT (LOAD) SPECIFICATION (continued)**

	Min	Max	Unit
Turn-On Time (60Hz)			
All relays		8.3	ms
Turn-Off Time (60Hz)			
All relays		8.3	ms
Off-State dv/dt			
All relays		500	V/μs
Operating Frequency			
All relays	10	440	Hz

**I<sup>2</sup>t for match fusing (<8.3ms)**

LS24D16C	128	A <sup>2</sup> S
LS24D21C	312	A <sup>2</sup> S
LS60D22C	450	A <sup>2</sup> S
LS24D27C	1800	A <sup>2</sup> S
LS60D27C	1800	A <sup>2</sup> S
LS60D30C	5000	A <sup>2</sup> S

**ENVIRONMENTAL SPECIFICATION**

	Min	Max	Unit
Operating Temperature	-40	80	°C
Storage Temperature	-40	120	°C
Input-Output Isolation	4000		Vrms
Output-Case Isolation	3300		Vrms

**NOTES:**

- MOV across the output recommended for non-resistive loads — minimum size: 14mm
- Maximum current based on size of the heat sink and the ambient temperature.
- For 800Hz applications, contact factory.
- For additional/custom options, contact factory.

**SURGE CURRENTS**

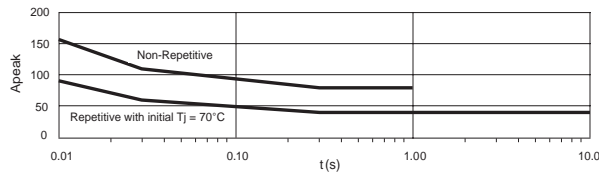

Figure 6a — LS24D16C relay

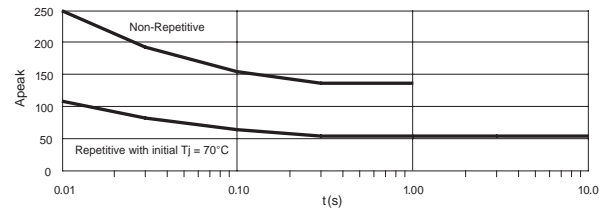

Figure 6b — LS24D21C relay

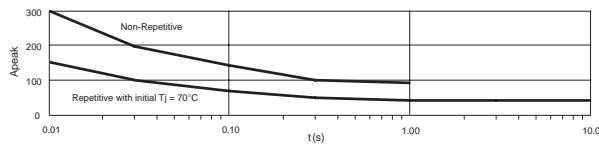
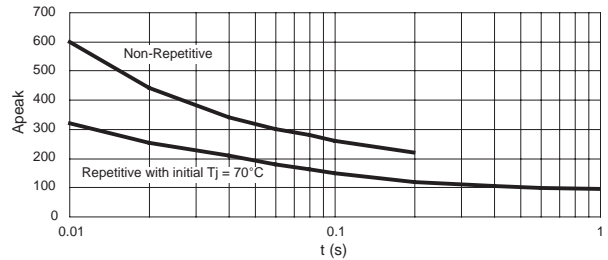

Figure 6c — LS60D22C relay



Long time overload @ Tj init = 45°C	Temps	60 s	100 s
	I (A)	20	15

Figure 6d — LS60D27C, LS24D27C relays

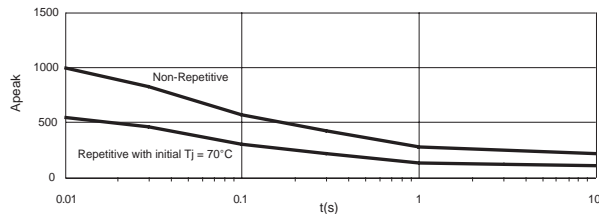

Figure 6e — LS60D30C relay

**MOUNTING EXAMPLES**

Heat sinks references:

FW100: L=100mm about 4°C/W (1SSR) without ventilation (3.6°C/W with 4SSRs )

FW150: L=150mm about 3°C/W (1SSR) without ventilation (2.6°C/W with 6SSRs )

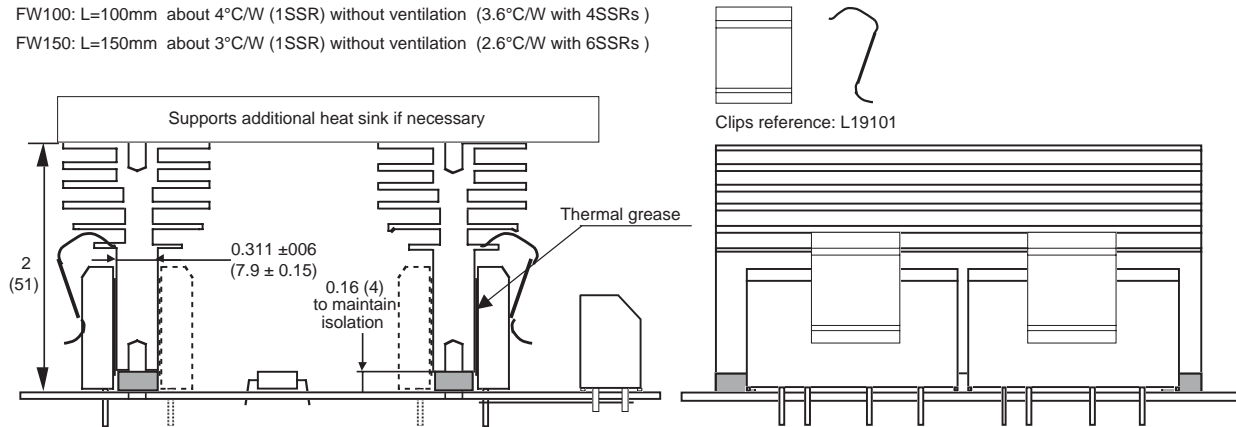

*Figure 7a — Thermal heat sinks with mounting clips; dimensions in inches (mm)*

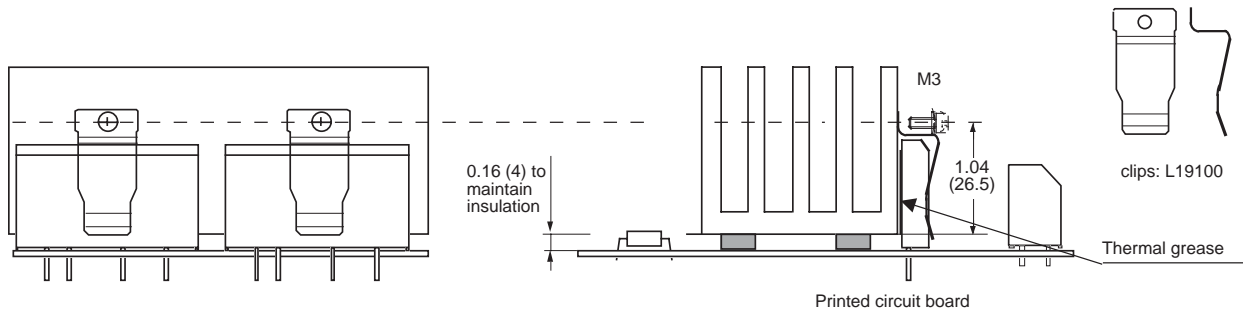

*Figure 7b — Clips with screws on standard heat sinks; dimensions in inches (mm)*

In each case, allow 0.16 in. (4mm) between the printed circuit board and the heat sink to keep a correct insulation between input to output (0.16 in./4mm insulated washer). To maintain a good contact between the SSR and the heat sink, use thermal grease.

**MECHANICAL SPECIFICATION**

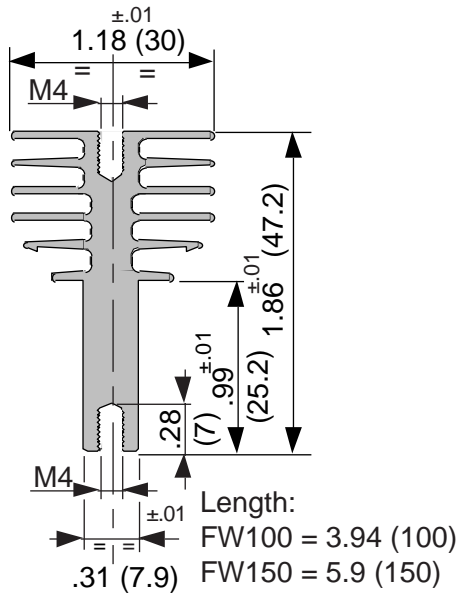

Figure 8 – FW100 and FW150 heat sinks; dimensions in inches (mm)

**FW100 heat sink with Max Clip System\***

Rth = 3.6°C/W (4 SSRs)

Rth = 4°C/W (1 SSR)

**FW150 heat sink with Max Clip System\***

Rth = 2.6°C/W (4 SSRs)

Rth = 3°C/W (1 SSR)

\*The Max Clip System of Aavid Thermalloy, patented worldwide

**L19101 CLIP**

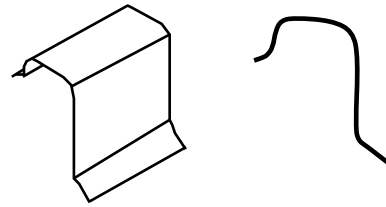

Figure 9a – Clip for FW100 and FW150 heat sinks

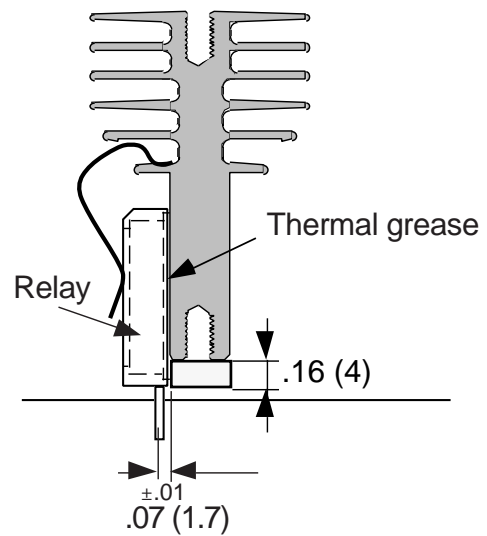

Figure 9b – Mounting with L19101 clip; dimensions in inches (mm)

**L19100 CLIP**

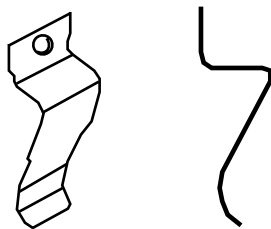

Figure 10a – Clips with screws for other heat sinks

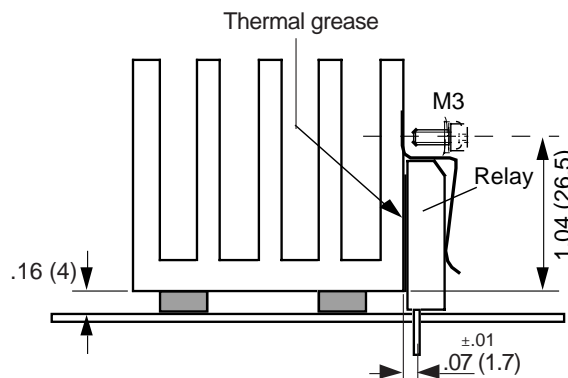

Figure 10b – Mounting with L19100 clip; dimensions in inches (mm)

**NOTES**

1. 0.16-inch (4mm) mounting washer must have correct insulation between input to output.

**LS WITH HS1 HEAT SINK**



Figure 11 – LS with HS1

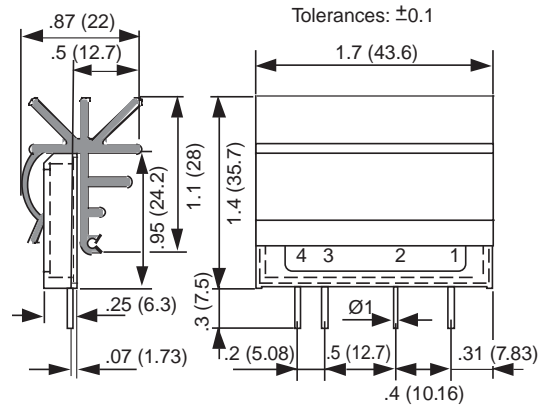

WEIGHT:  
1.06 oz. (30g)

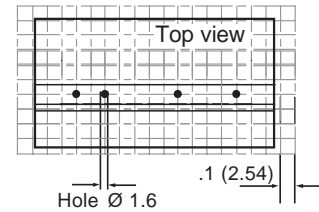

Figure 12 — LS relays with HS1; dimensions in inches (mm)

**INPUT (CONTROL) SPECIFICATION**

	Min	Max	Units
Control Range			
LS24D16C-HS1	4	14	Vdc
LS60D22C-HS1	4	14	Vdc
LS24D16N-HS1	8	32	Vdc

**Input Current Range**

LS24D16C-HS1	6.5	30	mAdc
LS60D22C-HS1	6.5	30	mAdc
LS24D16N-HS1	3.5	18	mAdc

**Must Turn-Off Voltage**

All relays	1	Vdc
------------	---	-----

**Input Resistance (Typical)**

LS24D16C-HS1	440	Ohms
LS60D22C-HS1	440	Ohms
LS24D16N-HS1	1640	Ohms

**LOAD CURRENT DERATING CURVE**

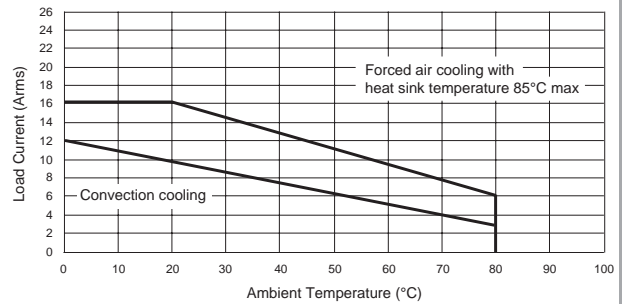

Figure 13a — LS24D16X-HS1 relays

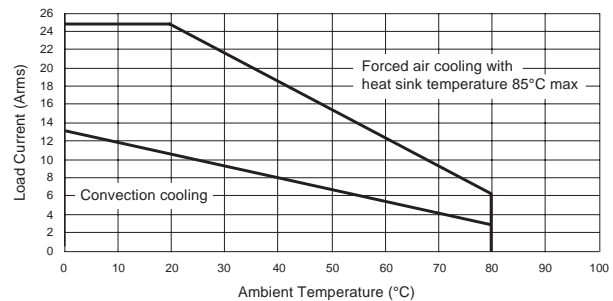

Figure 13b — LS60D22N-HS1 relays